

CRYSTAL OSCILLATORS NAOL(2x2.5) SERIES(Ceramic Package)

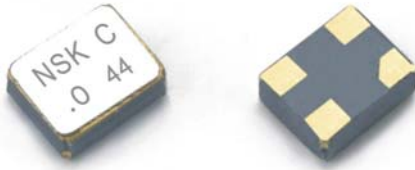

Application of SMD LVDS:

- SD Card
- Portable Mutli-Media Player
- Portable PC
- HDD
- DOA Terminal
- CCD
- Digital Camera
- Wireless LAN



{Features}

Seam Seal
 Low Power Consumption
 Tri-State
 Excellent Solderability
 RoHS Compliant

Specification:

Model		NAOL 22		
FREQ. RANGE	MHz	2.000 ~ 50.000		
FREQ. STABILITY*	PPM	A:±100 B:±50 C: ±30 D: ±25		
TEMP. RANGE				
OPERATING TEMP.	°C	0 ~ 70 , -40 ~ 85		
STORAGE TEMP.	°C	-55 ~ 125		
POWER SUPPLY VOLTAGE	V DC	2.5V±5%	1.8V±5%	3.3V±10%
OUTPUT LEVEL		CMOS		
OUTPUT SYMMETRY	%	40% ~ 60% (at 50% VDC)		
INPUT CURRENT				
1 ~ 9.99 MHz	mA (Max)	6		7
10 ~ 19.99 MHz		8		7
20 ~ 31.99 MHz		8		12
32 ~ 50.00 MHz		20		20
RISE / FALL TIME				
1 ~ 9.99 MHz	nS (Max)	7		6
10 ~ 19.99 MHz		7		6
20 ~ 31.99 MHz		6		5
32 ~ 50.00 MHz		9		5
OUTPUT LOAD		15 PF		
AGING	ppm/Year	±3		

*Inclusive of 25°C±3°C & Operating Temperature Range

*Symmetry of 45%~55% is available



CRYSTAL OSCILLATORS:

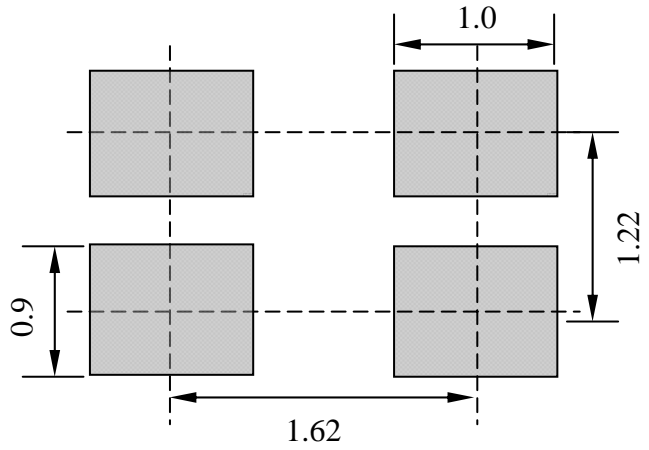
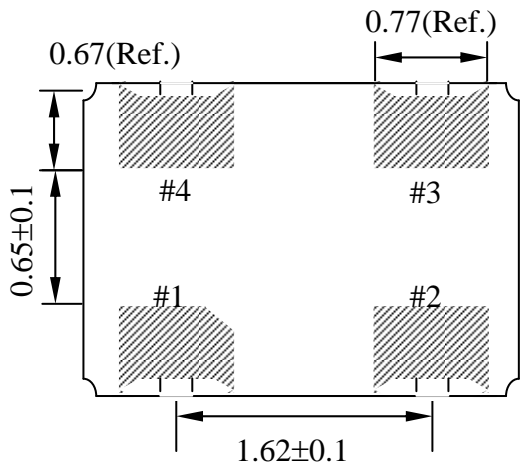
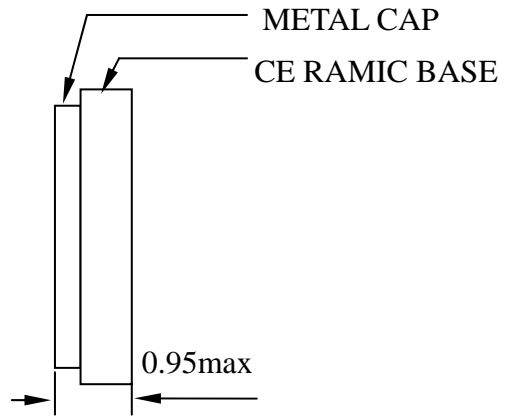
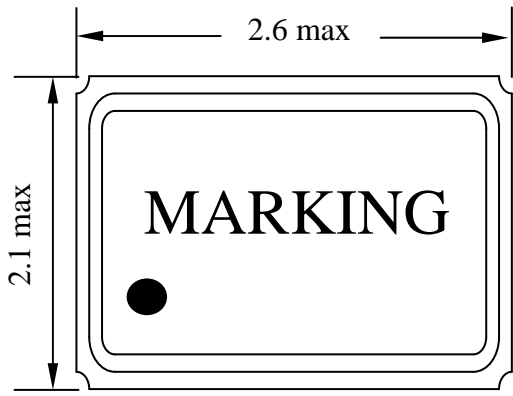

< TOP VIEW >

(Recommended Land Pattern)

#1: ENABLE / DISABLE FUNCTION

INH (PIN 1)	→	OUTPUT (PIN 3)	# NO.: define	
High (OPEN)	→	Operating	#4: VDD	#3: OUTPUT
LOW	→	High impedance	#1: E/D	#2: GND

Tape specification(mm) :

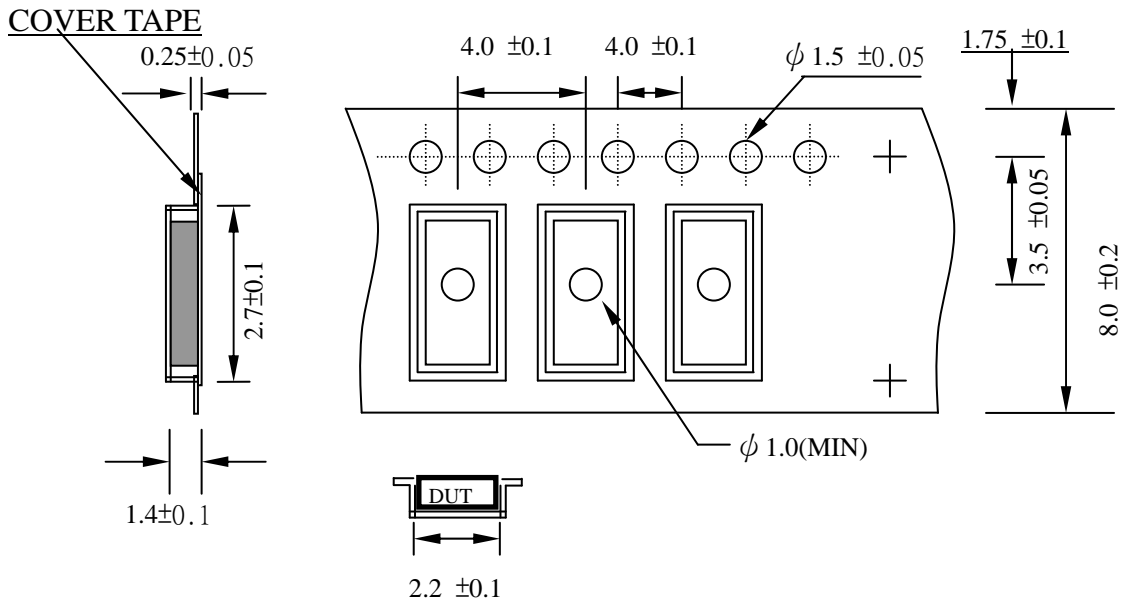

Reel packing : (mm)

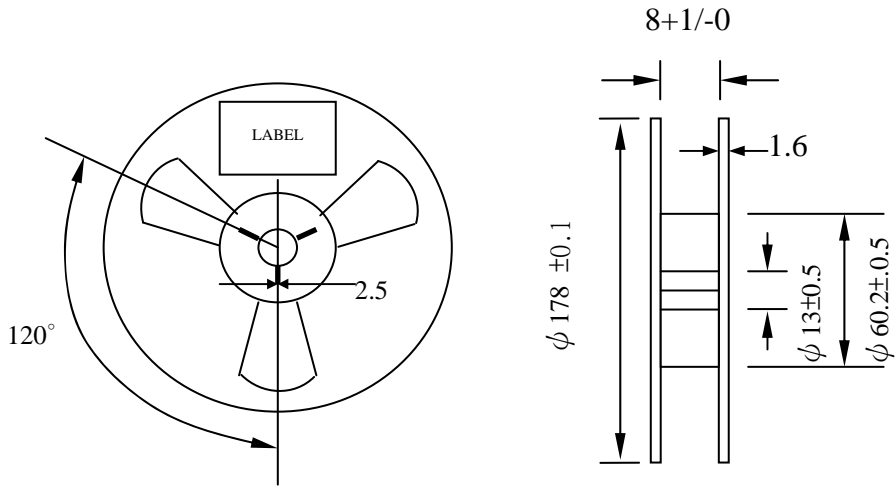

Reflow Temperature Profile:

